

SOLUTIONS

PROGRESS TEST-3A

MRBPA-1801

NEET PATTERN

Test Date: 05-11-2017



PHYSICS

1. (1)

As, we know that for the resultant vectors R,

$$R^2 = A^2 + B^2 + 2AB \cos \theta$$

On substituting, $A = (x + y)$, $B = (x - y)$ and

$$R = \sqrt{x^2 + y^2}$$

$$x^2 + y^2 = (x + y)^2 + (x - y)^2 + 2(x + y)(x - y) \cos \theta$$

$$x^2 + y^2 = x^2 + y^2 + 2xy + x^2 + y^2 - 2xy + 2(x^2 - y^2) \cos \theta$$

$$-(x^2 + y^2) = 2(x^2 - y^2) \cos \theta$$

$$\text{we get, } \theta = \cos^{-1} \left[-\frac{(x^2 + y^2)}{2(x^2 - y^2)} \right]$$

2. (2)

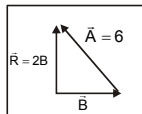

$$\text{So, } (6)^2 = (B)^2 + (2B)^2 \Rightarrow B = \frac{6}{\sqrt{5}}$$

3. (1)

$$\vec{r} = \vec{a} + \vec{b} + \vec{c} = 4\hat{i} - \hat{j} - 3\hat{i} + 2\hat{j} - \hat{k} = \hat{i} + \hat{j} - \hat{k}$$

$$\hat{r} = \frac{\vec{r}}{|\vec{r}|} = \frac{\hat{i} + \hat{j} - \hat{k}}{\sqrt{1^2 + 1^2 + (-1)^2}} = \frac{\hat{i} + \hat{j} - \hat{k}}{\sqrt{3}}$$

4. (1)

Area of a parallelogram = $|\vec{a} \times \vec{b}|$ where, \vec{a} and \vec{b} are sides of parallelogram

$$\text{Given, } \vec{a} = \vec{p} = 5\hat{i} - 4\hat{j} + 3\hat{k} \text{ and } \vec{b} = \vec{q} = 3\hat{i} + 2\hat{j} - \hat{k}$$

$$\vec{a} \times \vec{b} = \begin{vmatrix} \hat{i} & \hat{j} & \hat{k} \\ 5 & -4 & 3 \\ 3 & 2 & -1 \end{vmatrix}$$

$$\vec{a} \times \vec{b} = \hat{i}(4 - 6) - \hat{j}(-5 - 9) + \hat{k}(10 + 12)$$

$$\vec{a} \times \vec{b} = 2\hat{i} + 14\hat{j} + 22\hat{k}$$

Thus, area,

$$|\vec{a} \times \vec{b}| = \sqrt{(2)^2 + (14)^2 + (22)^2} = \sqrt{684} \text{ sq units}$$

5. (4)

$$\vec{A} = \cos \omega t \hat{i} + \sin \omega t \hat{j}$$

$$\vec{B} = \cos \frac{\omega t}{2} \hat{i} + \sin \frac{\omega t}{2} \hat{j}$$

For \vec{A} and \vec{B} orthogonal $\vec{A}\vec{B} = 0$

$$(\cos \omega t \hat{i} + \sin \omega t \hat{j}) \cdot \left(\cos \frac{\omega t}{2} \hat{i} + \sin \frac{\omega t}{2} \hat{j} \right) = 0$$

$$\cos \omega t \cdot \cos \frac{\omega t}{2} + \sin \omega t \cdot \sin \frac{\omega t}{2} = 0$$

$$\cos \left(\omega t - \frac{\omega t}{2} \right) = 0$$

$$\Rightarrow \cos \frac{\omega t}{2} = 0$$

$$\frac{\omega t}{2} = \frac{\pi}{2} \Rightarrow \omega t = \pi \quad \Rightarrow \quad t = \frac{\pi}{\omega}$$

6. (2)

For two particles to collide, the direction of the relative velocity of one with respect to other should be directed towards the relative position of the other particle

i.e., $\frac{\vec{r}_1 - \vec{r}_2}{|\vec{r}_1 - \vec{r}_2|} \rightarrow$ direction of relative position of 1 w.r.t. 2.

and $\frac{\vec{v}_2 - \vec{v}_1}{|\vec{v}_2 - \vec{v}_1|} \rightarrow$ direction of velocity of 2 w.r.t. 1.

so for collision of A and B

$$\frac{\vec{r}_1 - \vec{r}_2}{|\vec{r}_1 - \vec{r}_2|} = \frac{\vec{v}_2 - \vec{v}_1}{|\vec{v}_2 - \vec{v}_1|}$$

7. (1)

For both cases $t = \sqrt{\frac{2h}{g}} = \text{constant}$.

Because vertical component of velocity will be zero for both the particles.

8. (2)

$$R = \frac{u^2 \sin 2\theta}{g} = \frac{2u^2 \sin \theta \cos \theta}{g}$$

$$H = \frac{u^2 \sin^2 \theta}{2g}$$

$$\frac{H}{R} = \frac{u^2 \sin^2 \theta}{2g} \times \frac{g}{2u^2 \sin \theta \cos \theta} = \frac{\sin \theta}{4 \cos \theta}$$

$$\Rightarrow \frac{H}{R} = \frac{4 \cos \theta}{\sin \theta} \text{ or, } \frac{R}{H} = 4 \cot \theta$$

9. (2)

$$\vec{v} = \hat{i} + 2\hat{j}$$

$$\Rightarrow x = t$$

$$y = 2t - \frac{1}{2}(10t^2)$$

From (i) and (ii), $y = 2x - 5x^2$

10. (3)

$$u_y = 40 \text{ m/s}, F_y = -5 \text{ N}, m = 5 \text{ kg}$$

$$\text{So, } a_y = \frac{F_y}{m} = -1 \text{ m/s}^2 \text{ (As } v = u + at)$$

$$\therefore v_y = 40 - 1 \times t = 0 \Rightarrow t = 40 \text{ sec.}$$

11. (4)

$$\vec{p}(t) = A(\hat{i} \cos kt - \hat{j} \sin kt)$$

$$\vec{F} = \frac{d}{dt}(\vec{p}(t)) = Ak(-\hat{i} \sin kt - \hat{j} \cos kt)$$

$$\vec{F} \cdot \vec{p} = A^2 k(-\cos kt \sin kt + \sin kt \cos kt) = 0$$

\therefore The momentum and force are perpendicular to each other at 90° ,

12. (4)

Rate of flow of water

$$\frac{V}{t} = \frac{10 \text{ cm}^3}{\text{sec}} = 10 \times 10^{-6} \frac{\text{m}^3}{\text{sec}}$$

$$\text{Density of water } \rho = \frac{10^3 \text{ kg}}{\text{m}^3}$$

$$\text{Cross-sectional area of pipe } A = \pi(0.5 \times 10^{-3})^2$$

$$\text{Force} = m \frac{dv}{dt} = \frac{mv}{t} = \frac{V\rho w}{t} = \frac{\rho V}{t} \times \frac{V}{At} = \left(\frac{V}{t}\right)^2 \frac{\rho}{A} \quad \left(\because v = \frac{V}{At}\right)$$

By substituting the value in the above formula we get $F = 0.127 \text{ N}$

13. (1)

On the frictionless incline plane block has acceleration $a = g \sin \theta$ its vertical component as shown in figure is $a = g \sin^2 \theta$

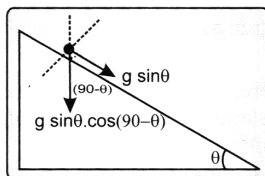

Hence relative vertical acceleration of A w.r.t. B is

$$a_{AB} = g[\sin^2 \theta_1 - \sin^2 \theta_2]$$

$$= g[\sin^2 60^\circ - \sin^2 30^\circ] = 9.8 \left[\frac{3}{4} - \frac{1}{4} \right] = 4.9 \text{ m/s}^2$$

14. (3)

Acceleration due to gravity along inclined

$$g' = g \cos(90^\circ - \theta) = g \sin \theta$$

$$\therefore \text{Time taken, } t = \sqrt{\frac{2s}{g'}} = \sqrt{\frac{2l}{g \sin \theta}}$$

$$\text{But } \sin \theta = \frac{h}{l} \Rightarrow l = \frac{h}{\sin \theta}$$

$$\text{hence, } t = \sqrt{\frac{2}{2 \sin \theta} \cdot \frac{h}{\sin \theta}}$$

$$t = \frac{1}{\sin \theta} \sqrt{\frac{2h}{g}}$$

15. (1)

As body just starts to slide down at an angle 30° so

$$\mu = \tan \alpha = \tan 30^\circ$$

$$\Rightarrow \mu = \frac{1}{\sqrt{3}}$$

16. (3)

$$\text{Normal reaction } R = mg - P \sin 30^\circ = mg - \frac{P}{2}$$

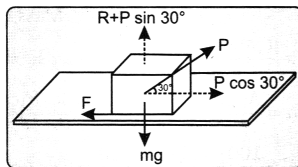
 \therefore Limiting friction between body and surface is given

$$\text{by, } F = \mu R = \mu \left(mg - \frac{P}{2} \right)$$

17. (2)

$$\text{For smooth } d = \frac{1}{2(g \sin \theta)} t_1,$$

$$\text{For rough plane } d = \frac{1}{2}(g \sin \theta - \mu g \cos \theta) t_2$$

$$t_1 = \sqrt{\frac{2d}{g \sin \theta}}$$

$$t_2 = \sqrt{\frac{2d}{g \sin \theta - \mu g \cos \theta}}$$

According to question, $t_2 = n t_1$

$$n \sqrt{\frac{2d}{g \sin \theta}} = \sqrt{\frac{2d}{g \sin \theta - \mu g \sin \theta}}$$

μ , applicable here, is kinetic friction as the block moves over the inclined plane.

$$n = \frac{1}{\sqrt{1 - \mu_k}}$$

$$\left(\because \cos 45^\circ = \sin 45^\circ = \frac{1}{\sqrt{2}} \right)$$

$$n^2 = \frac{1}{1 - \mu_k} \text{ or } 1 - \mu_k = \frac{1}{n^2}$$

$$\text{or } \mu_k = 1 - \frac{1}{n^2}$$

18. (2)

According to question,

$$mg(\sin \phi + \mu \cos \phi) = 2mg(\sin \phi - \mu \cos \phi)$$

$$\Rightarrow \tan \phi = 3\mu$$

$$\text{As, } \mu = \tan \theta$$

$$\text{Som } \tan \phi = 3 \tan \theta$$

19. (4)

$$S = \frac{u^2}{2\mu g} = \frac{m^2 u^2}{2\mu g m^2} = \frac{P}{2\mu m^2 g}$$

20. (2)

Person will feel his weight less when the lift goes down with some acceleration.

21. (1)

All blocks are moving with constant velocity so net force on all blocks are zero.

22. (3)

Due to Newton's third law

23. (1)

$$\text{For equilibrium of system, } F_1 = \sqrt{F_2^2 + F_3^2}$$

$$[\text{As } \theta = 90^\circ]$$

$$\text{In the absence of force } F_1, \text{ Acceleration} = \frac{\text{Net force}}{\text{Mass}} = \sqrt{\frac{F_2^2 + F_3^2}{m}} = \frac{F_1}{m}$$

24. (1)

$$W_{A \rightarrow B} = U_B - U_A = q(V_B - V_A)$$

$$V_B - V_A = \frac{W_{A \rightarrow B}}{q}$$

25. (4)

Net electric flux from a closed surface in uniform electric field is always zero.

26. (1)

Three capacitors are in series their resultant capacity is given by

$$\frac{1}{C_s} = \frac{1}{\left(\frac{\epsilon_0 K_1 A}{d_1}\right)} + \frac{1}{\left(\frac{\epsilon_0 K_2 A}{d_2}\right)} + \frac{1}{\left(\frac{\epsilon_0 K_3 A}{d_3}\right)}$$

$$\text{or } \frac{1}{C_s} = \frac{1}{C_s} = \frac{d_1}{\epsilon_0 K_1 A} + \frac{d_2}{\epsilon_0 K_2 A} + \frac{d_3}{\epsilon_0 K_3 A}$$

$$\frac{1}{C_s} = \frac{1}{\epsilon_0 A} \left(\frac{d_1}{K_1} + \frac{d_2}{K_2} + \frac{d_3}{K_3} \right)$$

$$\therefore C_s = \frac{\epsilon_0 A}{\left(\frac{d_1}{K_1} + \frac{d_2}{K_2} + \frac{d_3}{K_3} \right)}$$

27. (4)

Capacitors C_1 and C_2 are in series with C_3 in parallel with them.

$$\text{Now, } C_1 = \frac{K_1 \epsilon_0 (A/2)}{(d/2)} = \frac{K_1 \epsilon_0 A}{d} \quad C_2 = \frac{K_2 \epsilon_0 (A/2)}{(d/2)} = \frac{K_2 \epsilon_0 A}{d}$$

$$\text{and } C_3 = \frac{K_3 \epsilon_0 A}{2d} \quad C_{\text{equivalent}} = C_3 + \frac{C_1 C_2}{C_1 + C_2}$$

$$= \frac{K_3 \epsilon_0 A}{2d} + \frac{\left(\frac{K_1 \epsilon_0 A}{d}\right) \left(\frac{K_2 \epsilon_0 A}{d}\right)}{\frac{K_1 \epsilon_0 A}{d} + \frac{K_2 \epsilon_0 A}{d}} = \frac{\epsilon_0 A}{d} \left(\frac{K_3}{2} + \frac{K_1 K_2}{K_1 + K_2} \right)$$

So, none option is correct.

28. (2)

The given combination is a balanced Wheatstone bridge in parallel with 10 C.

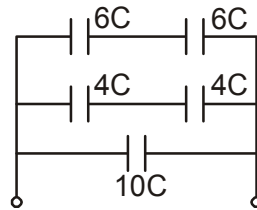

29. (2)

The circuit can be redrawn as

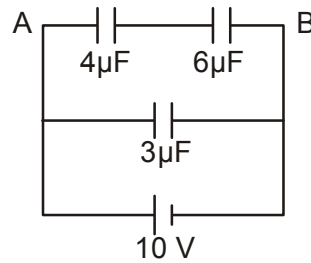

Here $4\mu\text{F}$ and $6\mu\text{F}$ are in series. So, charge is same on both.
Now equivalent capacity between A and B

$$C_{AB} = \frac{6 \times 4}{6 + 4} = 2.4\mu\text{F}$$

So, charge on $4\mu\text{F}$ capacitor

$$\begin{aligned} Q &= C_{AB} \times 10 \\ &= 2.4 \times 10 \\ &= 24 \mu\text{C} \end{aligned}$$

30. (4)

Equivalent capacitance between A and B

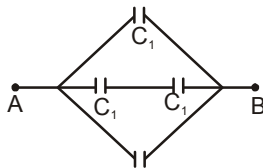

$$C_{AB} = C_1 + \frac{C_1}{2} + C_1 = \frac{5}{2}C_1$$

As charge $q = CV$

$$\text{So, } 1.5\mu\text{C} = \frac{5}{2}C_1 \times 6$$

$$\begin{aligned} \Rightarrow C_1 &= \frac{15}{5} \times 10^{-6} \\ &= 0.1 \times 10^{-6} \text{F} = 0.1\mu\text{F} \end{aligned}$$

31. (4)

Area = $\frac{1}{2}QV$ = energy stored in the capacitor.

32. (3)

33. (2)

$$U = \frac{1}{2}(2C)V^2 = CV^2 = \left(\frac{\epsilon_0 A}{d}\right)(V^2)$$

34. (2)

If ring is complete, net field at centre is zero. If small portion is cut, field opposite to this is not cancelled out.

35. (4)

$$q_Q = -q_p$$

From Gauss law we can prove that net electric field outside Q is zero.

36. (4)

$$\phi = \frac{2\pi R^2(1 - \cos 45^\circ)}{4R^2} \cdot \frac{q}{\epsilon_0}$$

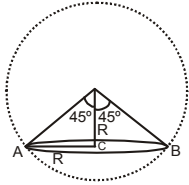

37. (3)

Given circuit can be redrawn as shown

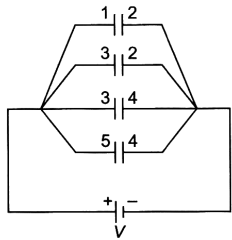

Capacity of each capacitor is $C = \frac{\epsilon_0 A}{d}$

So, magnitude of charge on each capacitor = magnitude of charge on each plate = $\frac{\epsilon_0 A}{d} V$

As plate 1 is connected with +ve terminal of battery, so charge on = $+\frac{\epsilon_0 A}{d} \cdot V$

Plante 4 comes twice and it is connected with -ve terminal of battery. So charge on plate 4 = $-\frac{2\epsilon_0 AV}{d}$

38. (3)

Given circuit can be redrawn as

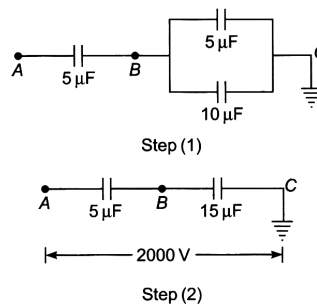

Potential difference between A and B

$$\text{i.e., } V_A - V_B = \left(\frac{15}{5+15}\right) \times 2000$$

$$\therefore V_A - V_B = 1500V$$

$$\therefore 2000 - V_B = 1500V$$

$$\therefore V_B = 500 V$$

39. (1)

$$\text{Here, } u = 0, a = \frac{qE}{m}$$

$$s = l \text{ and } v = ?$$

$$v^2 = u^2 + 2as$$

$$v^2 = 0 + 2 \frac{qEl}{m} \Rightarrow v = \sqrt{\frac{2qEl}{m}}$$

40. (4)

Electric field and electric potential at a general point at a distance r from the centre of the dipole is

$$E_g = \frac{1}{4\pi\epsilon_0} \frac{p}{r^3} \sqrt{(3\cos^2\theta + 1)}$$

$$\text{and } V_g = \frac{1}{4\pi\epsilon_0} \frac{p\cos\theta}{r^2}$$

41. (1)

Flux is due to charges enclosed per ϵ_0

$$\begin{aligned} \therefore \text{Total flux} &= (-14 \times 78.85 - 56) \text{ nC} / \epsilon_0 \\ &= 8.85 \times 10^{-9} \text{ C} \times \frac{4\pi}{4\pi\epsilon_0} \\ &= 8.85 \times 10^{-9} \times 9 \times 10^9 \times 4\pi \\ &= 1000.4 \text{ Nm}^2 / \text{C i.e., } 1000 \text{ Nm}^2\text{C}^{-1} \end{aligned}$$

42. (3)

$$\text{Initial energy, } U_i = \frac{1}{2} C_0 V_2$$

$$\text{Final energy, } U_f = \frac{1}{2} (KC_0) \left(\frac{V}{K}\right)^2$$

$$\text{or } U_f = \frac{1}{K} \left(\frac{1}{2} C_0 V_2\right)$$

$$\text{Change in energy} = U_f - U_i = \frac{1}{2} C_0 V_2 \left(\frac{1}{K} - 1\right)$$

43. (3)

Common potential, $V = \frac{\text{Total charge}}{\text{Total capacitance}}$

$$V = \frac{C_1 V_1 + C_2 V_2}{C_1 + C_2} = \frac{0 + CV_0}{KC + C} = \frac{CV_0}{C(1+K)}$$

$$V = \frac{V_0}{(1+K)} \Rightarrow K = \frac{V_0}{V} - 1 \Rightarrow K = \frac{V_0 - V}{V}$$

44. (1)

Electric field at a point is equal to the negative gradient of the electrostatic potential at that point.

Potential gradient relates with electric field according to the following relation $E = -\frac{dV}{dr}$

$$E = -\frac{\partial V}{\partial r} = \left[-\frac{\partial V}{\partial x} \hat{i} - \frac{\partial V}{\partial y} \hat{j} - \frac{\partial V}{\partial z} \hat{k} \right]$$

$$= [\hat{i}(2xy + z^3) + \hat{j}x^2 + \hat{k}3xz^2]$$

45. (3)

$$V = \frac{1}{4\pi\epsilon_0} \frac{q}{r}$$

Here, $V = 2V_{+ve} + 2V_{-ve}$

$$V = \frac{1}{4\pi\epsilon_0} \left[\frac{2q}{L} - \frac{2q}{L\sqrt{5}} \right]$$

$$V = \frac{2q}{4\pi\epsilon_0 L} \left(1 - \frac{1}{\sqrt{5}} \right)$$

CHEMISTRY

46. (3)

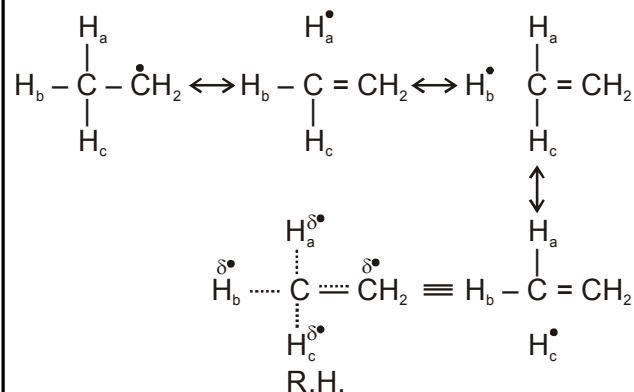

47. (4)

Carbanion in (I) is more stable than (II)

48. (4)

49. (1)

50. (4)

Ingold effect is also called inductive effect and it arises due to difference in electronegativity and hybridisation

51. (1)

52. (4)

1. is $\pi - \pi$ conjugation
2. is $\pi - \text{l.p}$ conjugation
3. is $\pi - \text{vacant p-orbital}$ conjugation so i.e. why show resonance

53. (4)

54. (4)

l.p. and vacant p-orbital conjugation provide more stability

55. (1)

56. (2)

Neutral C.S. are more stable

57. (3)

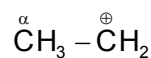
contain $\alpha - \text{H}$ so i.e. why show hyperjugation

58. (1)

59. (1)

60. (2)

61. (1)

1 litre of gas = 1.16 gas

22.7 litre of gas = (1.16 × 22.7) gm

62. (2)

63. (4)

 $\text{CuSO}_4 \cdot 5\text{H}_2\text{O} = 249.5 \text{ g}$, Cu : O = 1 : 9

$$\text{Cu} = 3.782 \text{ g} = \frac{3.782}{63.5} = 0.06 \text{ mol}$$

$$\therefore \text{O} = 0.54 \text{ mol} = 8.576 \text{ g}$$

64. (2)

$$2.0 \times 10^{23} \text{ atoms} = \frac{2.0 \times 10^{23}}{6.0 \times 10^{23}} = \frac{1}{3} \text{ mol atoms}$$

$$8 \text{ g O}_2 = \frac{1}{4} \text{ mol O}_2 = \frac{1}{2} \text{ mol O atoms}$$

$$3.0 \text{ g Be} = \frac{3}{9} \text{ mol Be} = \frac{1}{3} \text{ mol Be}$$

65. (1)

66. (3)

1 L air = 0.21 L O₂∴ 22.4 L O₂ under STP = 1 mol

$$\therefore 0.21 \text{ L O}_2 \text{ under STP} = \frac{0.21}{22.4} \\ = 0.0094 \text{ mol}$$

67. (3)

68. (4)

69. (4)

$$\lambda = 400 \text{ nm} = 400 \times 10^{-9} \text{ m}$$

$$(a) \quad v = \frac{c}{\lambda} = \frac{3 \times 10^8 \text{ m s}^{-1}}{400 \times 10^{-9} \text{ m}} = 7.5 \times 10^{14} \text{ s}^{-1} \text{ (Hz) Thus, true}$$

$$(b) \quad \bar{v} = \frac{1}{\lambda} = \frac{1}{400 \times 10^{-9}} = 2.5 \times 10^6 \text{ m}^{-1} \text{ Thus, true}$$

$$(c) \quad \lambda = \frac{h}{m\nu}$$

$$\therefore m\nu = \frac{h}{\lambda} = \frac{6.626 \times 10^{-34} \text{ J s}}{400 \times 10^{-9} \text{ m}} = 1.66 \times 10^{-27} \text{ kg ms}^{-1} \text{ Thus, true}$$

70. (3)

The number of waves made by a Bohr electron in an orbit is equal to its principal quantum number (or number of orbit).

71. (2)

Energy in ground state = 13.6 eV
Energy absorbed = $1.5 \times 13.6 \text{ eV} = 20.4 \text{ eV}$
Energy in higher level = $34.0 - 13.6 = 20.4 \text{ eV}$

\therefore energy emitted $34.0 - 13.6 = 20.4 \text{ eV}$

\therefore KE to the emitted electron = 20.4 eV

72. (2)

$$\bar{v} \text{ (wave number)} = \bar{R}_H Z^2 \left[\frac{1}{n_1^2} - \frac{1}{n_2^2} \right]$$

$$\bar{v}_1 \text{ (He}^+, Z = 2) = \bar{R}_H (2)^2 \left[\frac{1}{n_1^2} - \frac{1}{n_2^2} \right]$$

$$\bar{v}_2 \text{ (Be}^{3+}, Z = 4) = \bar{R}_H (4)^2 \left[\frac{1}{n_1^2} - \frac{1}{n_2^2} \right]$$

$$\frac{\bar{v}_2}{\bar{v}_1} = 4 \quad \therefore \quad \bar{v}_2 = 4\bar{v}_1 = 4x$$

73. (3)

Valence electron in P = 15 is in 3p

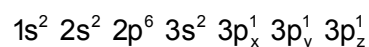

Then $n = 3$, $l = 1$, $m_l = -1$ or 0 or $+1$, $m_s = +\frac{1}{2}$

74. (1)

$$E_n = -13.6 \left(\frac{Z^2}{n^2} \right) \text{eV}$$

$E_1(\text{H}) = -13.6 \text{ eV}$ in ground state $n = 1$, for H - atom, $Z = 1$

$$E_2(\text{Be}^{3+}) = \frac{-13.6 \times (4)^2}{(2)^2} \text{] in first excited state,}$$

$n = 2$ for Be^{3+} , $Z = 4$

$$\therefore E_1 = E_2 = 1 : 4$$

75. (1)

$$\frac{1}{\lambda} = \bar{R}_H Z^2 \left[\frac{1}{n_1^2} - \frac{1}{n_2^2} \right]$$

For Lyman series $n_1 = 1$, λ is shortest if $n_2 = \infty$

$$\therefore \bar{R}_H = \frac{1}{x} \text{ for H - atom (Z = 1)}$$

For Balmer series, $n_1 = 2$, λ is longest if $n_2 = 3$

$$\frac{1}{\lambda_{\max}} = \left(\frac{1}{x} \right) (2)^2 \left[\frac{1}{2^2} - \frac{1}{3^2} \right] \text{ fole>k tkrk gS fd dksgyh lesr fdlh r He}^+ \text{ ion (Z = 2) } \lambda_{\max} = \frac{9x}{5}$$

76. (2) 77. (4) 78. (3) 79. (2) 80. (1)

81. (4) 82. (2) 83. (3)

84. (1)

The screening effect follows the order $s > p > d > f$.

85. (3)

86. (3)

ns^2p^1 is the electronic configuration of III A period. Al_2O_3 is amphoteric oxide.

87. (2)

88. (3)

While moving down in a group, effective nuclear attraction decreases due to addition of new orbitals. As a result ionisation potential decreases. Hence, the correct order $\text{Li} > \text{K} > \text{Cs}$.

89. (1)

Species	Na ⁺	Mg ²⁺	Al ³⁺	Si ⁴⁺
Protons	11	12	13	14
Electrons	10	10	10	10

Size of isoelectronic cations decreases with increase in magnitude of nuclear charge

∴ Order of decreasing size is ${}_{11}\text{Na}^+ > {}_{12}\text{Mg}^{2+} > {}_{13}\text{Al}^{3+} > {}_{14}\text{Si}^{4+}$

90. (3)

$(n-1)s^2p^6(n-1)d^{1-10}ns^{0-2}$ represents the correct electronic configuration of transition elements among the given choices.

BOTANY

91. (2)	92. (2)	93. (3)	94. (2)	95. (3)	96. (2)
97. (3)	98. (2)	99. (2)	100. (3)	101. (3)	102. (1)
103. (4)	104. (3)	105. (1)	106. (3)	107. (3)	108. (4)
109. (3)	110. (2)	111. (4)	112. (2)	113. (4)	114. (1)
115. (4)	116. (1)	117. (3)	118. (2)	119. (2)	120. (4)
121. (3)	122. (4)	123. (2)	124. (4)	125. (2)	126. (2)
127. (2)	128. (4)	129. (2)	130. (3)	131. (1)	132. (1)
133. (2)	134. (4)	135. (1)			

ZOOLOGY

136. (3)	137. (1)	138. (3)	139. (2)	140. (1)	141. (3)
142. (2)	143. (1)	144. (2)	145. (4)	146. (4)	147. (2)
148. (2)	149. (4)	150. (1)	151. (2)	152. (1)	153. (4)
154. (4)	155. (4)	156. (2)	157. (2)	158. (1)	159. (3)
160. (1)	161. (1)	162. (4)	163. (4)	164. (2)	165. (1)
166. (4)	167. (4)	168. (4)	169. (1)	170. (2)	171. (1)
172. (4)	173. (3)	174. (4)	175. (4)	176. (3)	177. (2)
178. (4)	179. (4)	180. (4)			